

365N

3-way brass ball valve with ISO 5211 pad for actuator, standard port, FNPT.

- Pressure rating 400 WOG-100 WSP.
- Temperature range -4°F to +366°F.
- ANSI B1.20.1 connections.
- Blow-out proof stem, chrome plated brass ball and double O-ring stem packing.
- P.T.F.E seats with O-ring backing for low operating torque.
- 100% electronically tested in the open and closed position at 80 psi.
- Not to be used for drinking water.
- Four seat design for sealing between pressurized ports. 355N: LEVER HANDLE - size 1/4" to 3", "T" flow pattern. 365N: LEVER HANDLE - size 1/4" to 3", "L" flow pattern.

Technical specifications

Drawing

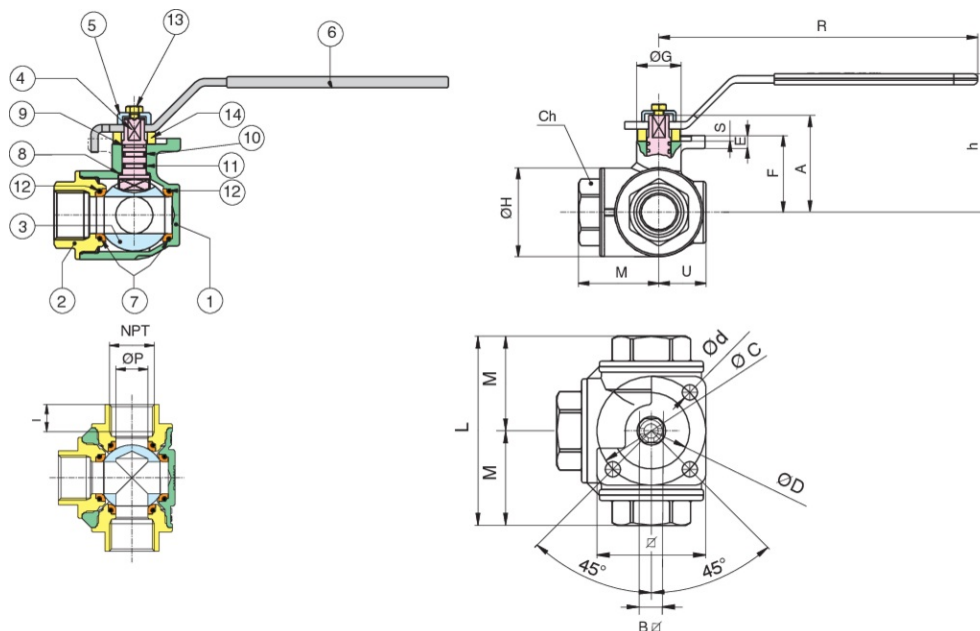

Materials

POSITION	PART NAME	MATERIAL	N.° PIECES
1	BODY	BRASS C37700	1
2	END CONNECTION	BRASS C37700	3
3	BALL	BRASS C37700	1
4	STEM	BRASS C38500	1
5	BUSH	BRASS C38500	1
6	HANDLE	FE DD 11 UNI EN 10111	1
7	BALL SEAT	P.T.F.E	4
8	THRUST WASHER	P.T.F.E	1
9	THRUST WASHER	P.T.F.E	1
10	O-RING	EPDM	1
11	O-RING	FKM (VITON)	1
12	O-RINGS BODY	FKM (VITON)	4
13	SCREW	STEEL CL 8.8	1
14	WASHER	NYLON (PA6)	1

Table

SIZE	ØP	ØH	I	L	M	CH	R	H	ØG	ØD	ØC	U	E	F	A	B	CV 355N-365N	PSI	WEIGHT (LBS)	BREAK TORQUE (IN/LBS)
1 1/2"	1.18	2.83	0.68	4.86	2.43	2.17	6.79	3.66	1.26	0.28	1.97	1.49	0.28	2.34	0.43	0.43	29.71	400	6.22	106.21
1 1/4"	0.95	2.36	0.68	4.39	2.19	1.97	6.79	3.17	0.94	0.28	1.97	1.22	0.28	1.85	0.43	0.43	18.73	400	4.15	88.51
1/2"	0.43	1.34	0.54	2.87	1.44	1.06	4.72	2.44	0.87	0.24	1.42	0.77	0.2	1.2	0.35	0.35	4.16	400	1.21	35.4
1/4"	0.39	1.34	0.39	2.64	1.32	0.87	4.72	2.44	0.87	0.24	1.42	0.77	0.2	1.2	0.35	0.35	3.24	400	1.23	35.4
1"	0.75	1.89	0.66	3.74	1.87	1.61	6.79	2.95	0.94	0.28	1.97	1	0.28	1.63	0.43	0.43	12.83	400	2.7	70.81
2 1/2"	1.95	4.37	0.93	6.93	3.46	3.35	9.06	4.8	1.46	0.35	2.76	2.2	0.31	3.35	0.59	0.55	70.05	400	19.78	265.52
2"	1.5	3.39	0.7	5.73	2.86	2.76	9.06	4.37	1.46	0.35	2.76	1.75	0.31	2.91	0.59	0.55	43.81	400	11.07	177.02
3/4"	0.55	1.54	0.55	3.19	1.59	1.26	4.72	2.52	0.87	0.24	1.42	0.87	0.2	1.29	0.35	0.35	7.05	400	1.48	35.4
3/8"	0.43	1.34	0.41	2.64	1.32	0.87	4.72	2.44	0.87	0.24	1.42	0.77	0.2	1.2	0.35	0.35	3.47	400	1.16	35.4
3"	1.95	4.45	1.02	7.09	3.54	4.13	9.06	4.8	1.46	0.35	2.76	2.2	0.31	3.35	0.59	0.55	70.05	400	19.63	265.52

Notes

WARNING: This product can expose you to chemicals including lead, which is known to the State of California to cause cancer and birth defects or other reproductive harm. For more information go to www.p65warnings.ca.gov.

Certifications

Technical Standards and
Safety Authority