

MOD. VB060

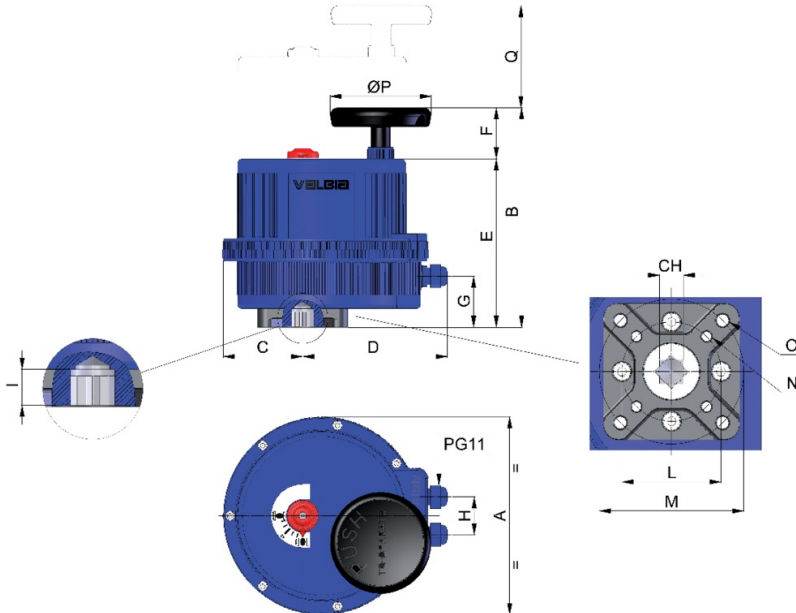

Technical specifications



SIZE	PATTERN ISO 5211	CH	A	B	C	D	E	F	G	H	I	L	M	N	O	ØP	Q
VB060	F05-F07	14	7.28	8.46	2.66	5.77	6.81	1.65	2.01	1.42	0.63	1.97	2.76	1/4-20 UNC 2BX0.59	5/16-18 UNC 2BX0.63	2.56	4.33

Certifications



C US

CSA International